

Contact Us: FACTORY UTV LLC

9237 Beatty Drive Sacramento, CA 95826

Phone : (916) 383-2730

E-mail : info@factoryutv.net

Go online: www.Factoryutv.net



FACTORY UTV

U.H.M.W. Skid Plate / Under Armor Package

Ultra. High. Molecular. Weight. polyethylene all terrain skid plate / under armor kit for UTV's

Installation Guide (A-Arm Guards)

Polaris RZR XP 1000 (2014 - 2021+)

Fits: XP 1000 and XP 4 1000 :

*EPS, Dynamix, High lifter Edition, Ride Command, Trails and Rocks, LE, Premium, Sport -
XP Turbo EPS, XP Turbo EPS Dynamix, XP Turbo EPS Fox Edition, XP Turbo LE.*



Polaris RZR XP 1000 (2014 - 2021+) A-Arm Guard installation

Fasten Loosely to allow for fitment adjustments, secure all bolts when complete.

Do Not Over Tighten Bolts Through Guards

Standard XP 1000 A-arm guards:



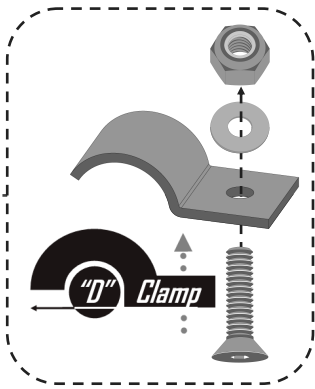
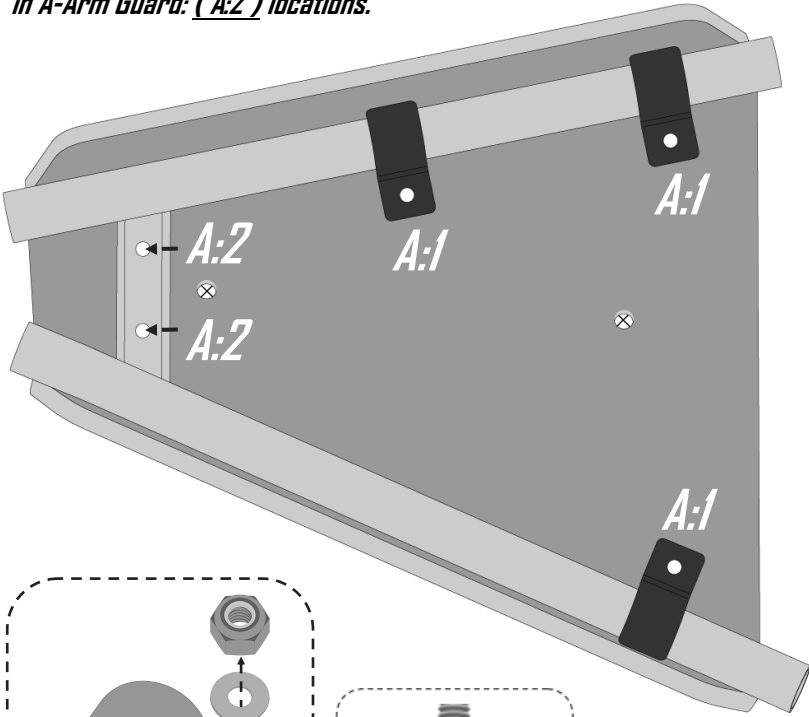

Hold in place, Use (3x) "D" clamps, (3x) 1/4"-20 x 1/4" Counter Sunk Bolts, (3x) Gold Washers w/ (3x) 1/4"-20 Ny-Lock Nuts in A-Arm Guard: (A:1) locations.

Use: (2x) 1/4"-20 x 1/4" Counter Sunk Bolts, (2x) Gold Washers w/ (2x) 1/4"-20 Ny-Lock Nuts, in A-Arm Guard: (A:2) locations.



Fasten bolts until flush DO NOT over tighten

A-Arm Guard Hardware

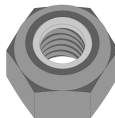
-  1" x 1" "D" Clamps (#C-D:2) **6x**
-  1/4"-20 x 1/4" Counter Sunk Bolt (#B-C:2) **6x**
-  1/4"-20 x 1/2" Counter Sunk Bolt (#B-C:3) **4x**
-  1/4" Gold Washers (#W-3) **10x**
-  1/4"-20 Ny-Lock Nut (#N-2) **10x**

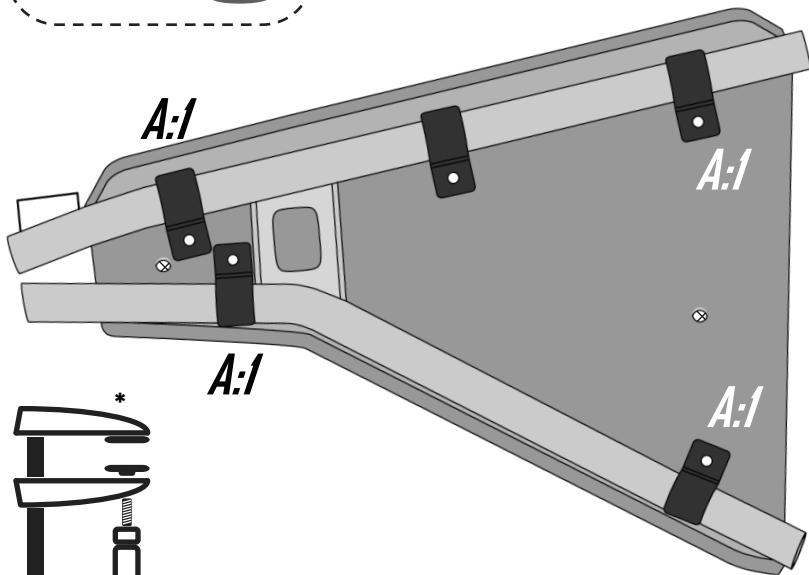

Polaris High Clearance A-Arm Guards (for High lifter or Trails and Rocks Editions)

Hold in place, Use (4x) "D" clamps, (4x) 1/4"-20 x 1/4" Counter Sunk Bolts, (3x) Gold Washers w/ (4x) 1/4"-20 Ny-Lock Nuts in A-Arm Guard: (A:1) locations.

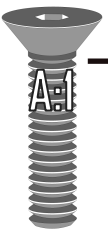

* Install Tip:
Use of clamps may help with fitment and aid with fastening bolts.

Polaris High Clearance A-Arm Guard

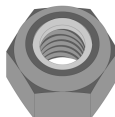
-  1" x 1/4" "D" Clamps (#C-D:3) **10x**
-  1/4"-20 x 1/4" Counter Sunk Bolt (#B-C:2) **10x**
-  1/4" Gold Washers (#W-3) **10x**
-  1/4"-20 Ny-Lock Nut (#N-2) **10x**

⊗ = Drainage Holes
Do Not Use For Mounting